

PowerCON SCARA **IXP** Series

PowerCON SCARA Program Controllers **MSEL-PCX/PGX**



Introducing the Cost-effective Pulse Motor Type IXP to the IX Series of SCARA Robots

All models come standard with battery-less absolute encoders.



1 More Affordable Due to Pulse Motors

By adopting pulse motors...

...the IXP costs around **1/2** a conventional model.

* Compared against an IAI robot based on an arm length of 350mm.

The IXP achieves a payload equivalent to that of a conventional model by adopting high-output drivers.

2 All Models Come Standard with Battery-less Absolute Encoders

All IXP models come standard with battery-less absolute encoders that does not require batteries. Since battery replacement is no longer necessary, maintenance man-hours are reduced.

Advantages of Battery-less Absolute Encoders

- The machine will not stop due to battery errors (low voltage, etc.)
- No cost of battery replacement
- No need for absolute reset or other physical tasks associated with battery replacement

3 Lighter than a Conventional Model

The robot weighs approx. **30% less.**
(Compared to: IX-NNN3515)

The lightweight robot can be easily assembled into your equipment.

Model	IX-NNN3515H (Conventional product)	IXP-4N3515 (New product)
Mass	18kg	-5kg → 13kg

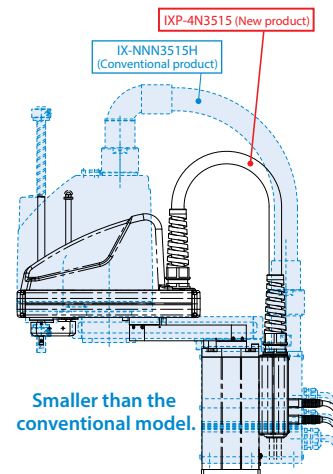

1

4

Added 3-axis Specification and 4-axis* Gripper Specification

The 3-axis specification has no rotational axis for greater allowable inertial load moment. It can be combined with a dedicated gripper to constitute a transfer robot with ease.

* The gripper type has four axes including three SCARA robot axes and one gripper axis.



Use Examples of the 3-axis Specification

- Work processes that require only three axes
 - ➔ Pickup and placement of circular parts, non-directional transfer, etc.

Inspecting cans for defects

Defects are identified using an external camera and are screened out.

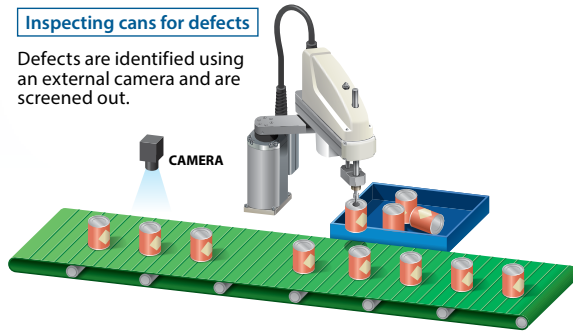



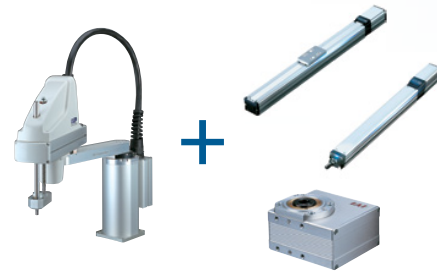





- Connecting an actuator as the fourth axis
A ROBO Cylinder of a rotary type, rod type, slider type, etc., can be connected to a SCARA robot 3-axis specification as its fourth axis.



5

Product Lineup

Arm length		350mm		450mm	
SCARA type		3 axes	4 axes (with rotational axis)	3 axes	4 axes (with rotational axis)
Gripper	None	 IXP-3N3515 Controller: MSEL, 3-axis specification	 IXP-4N3515 Controller: MSEL, 4-axis specification	 IXP-3N4515 Controller: MSEL, 3-axis specification	 IXP-4N4515 Controller: MSEL, 4-axis specification
	Medium gripper type RCP4-GRSML	 IXP-3N3515GM Controller: MSEL, 4-axis specification	—	 IXP-3N4515GM Controller: MSEL, 4-axis specification	—
	Large gripper type RCP4-GRSLL	 IXP-3N3510GL Controller: MSEL, 4-axis specification	—	 IXP-3N4510GL Controller: MSEL, 4-axis specification	—

Introducing the PowerCON SCARA Robot Program Controller **MSEL** with High-output Driver (PowerCON)



1 Accommodating Significantly More Programs and Positions

The greater storage capacity accommodates significantly more programs and positions.

	XSEL-PX (Conventional product)	MSEL (New product)
Number of programs	128	255
Number of positions	20,000	30,000

2 Smaller Size

Having a size of 130mm in width x 195mm in height, the MSEL is significantly smaller than a conventional controller and saves space in your control panel. The MSEL can be installed with screws or using a DIN rail.

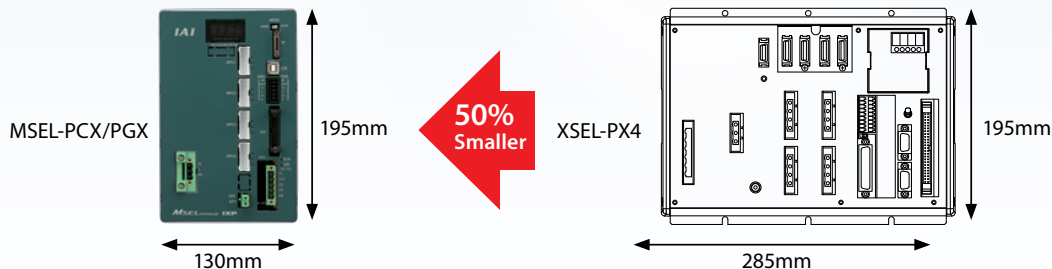

3 Safety Category Compliant

By building an appropriate external circuit, the MSEL meets the safety circuit requirements of any of Safety Categories 1 to 3.

4 Supporting Diverse I/O Interfaces

Standard PIOs (IN: 16 points, OUT: 16 points) and one expansion I/O slot are available. For the expansion I/O slot, PIOs (IN: 16 points, OUT: 16 points) or field network (CC-Link, DeviceNet, PROFIBUS-DP or EtherNet/IP) can be selected.



Expansion I/O slot

PIO	IN: 16 points, OUT: 16 points
Field network	

3

Applications

Part Screening

Parts of two different sizes are discriminated using a sensor and sorted into different boxes.

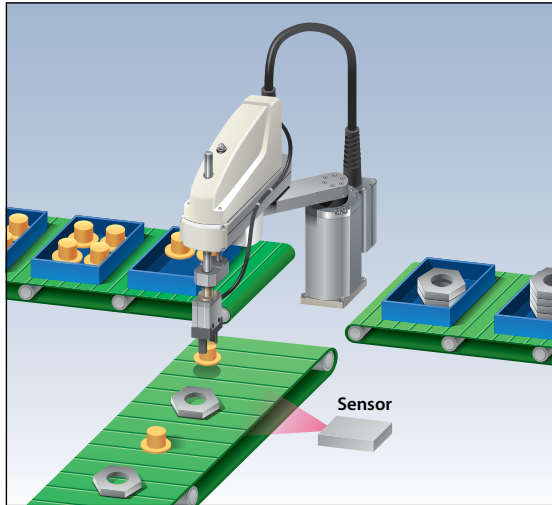

Solar Battery Module Tab Solder

Solar battery module cells are transferred while position-compensated so that electrodes can be soldered onto the cells.

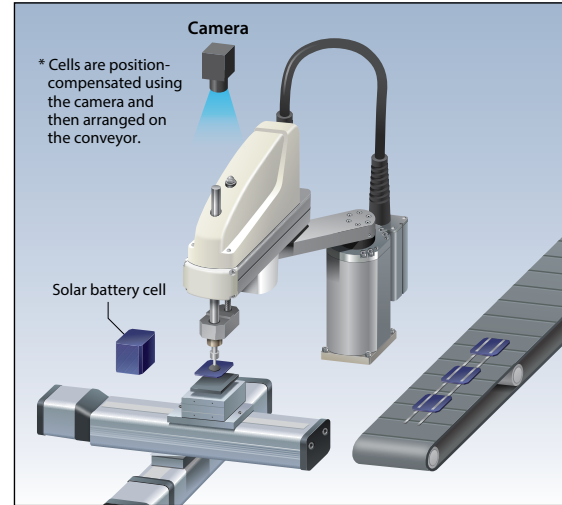

DVD-R Packing

DVD-Rs are picked up from the conveyor and placed.

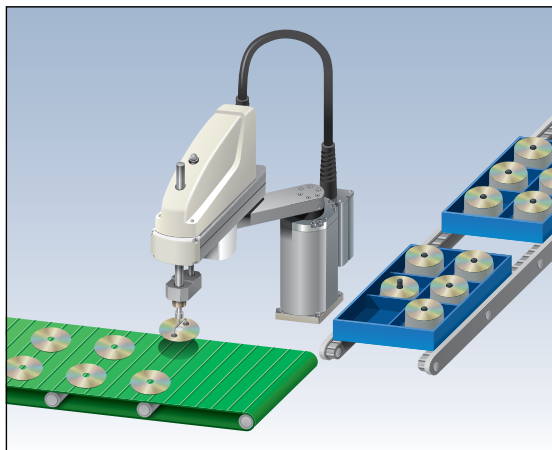

Adhesive Application

Adhesive is applied onto circular parts.

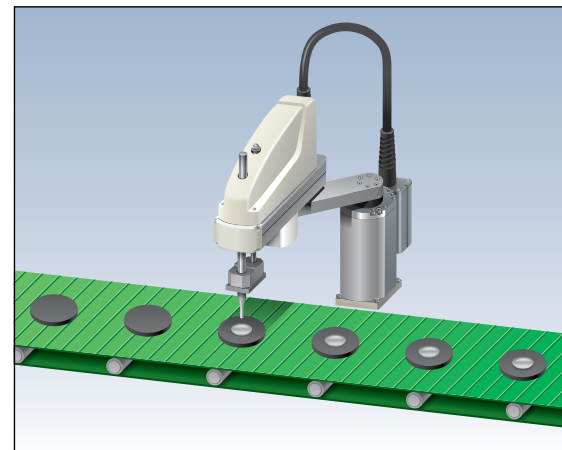

*1 Positioning Repeatability

Positioning repeatability refers to the degree to which the robot can repeat the same positioning when operated at the same speed and acceleration/deceleration using the same arm system between two points including the start position and target position. (The values were measured at a constant ambient temperature of 20°C). Note that the positioning repeatability may be out of specification if the arm is changed, if the positioning is from multiple different positions to a single set position, or if the operating conditions, such as the operating speed and acceleration/deceleration settings, are changed.

Notes on the Low-resolution Encoders

Since the IXP is equipped with low-resolution encoders, feasible positioning points of the robot are wider apart and positioning to a specific command position may not be possible. Also note that the target position cannot be finely adjusted by less than the minimum travel.

			IXP-3N3515 3N3510	IXP-3N4515 3N4510	IXP-4N3515	IXP-4N4515
Minimum travel	In the horizontal plane (Arm 1 + Arm 2)	mm	0.202 (MAX)	0.179 (MAX)	0.202 (MAX)	0.179 (MAX)
	Vertical axis	mm	0.009	0.009	0.009	0.009
	Rotational axis	Degree	—	—	0.113	0.113

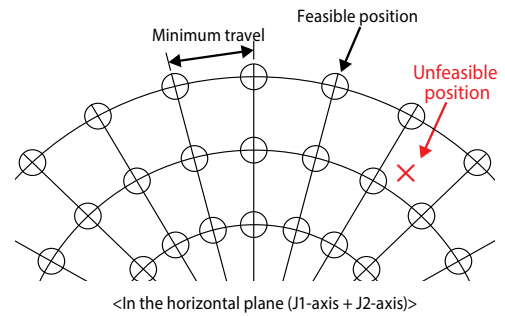

*2 Maximum Operating Speed for PTP Operation

The maximum operating speed in the specification table assumes PTP command operation.

The speed is limited for CP operation command (interpolation) operation. For details, refer to “CP Operation” under “Rough Guide for SCARA Robot Acceleration/Deceleration Setting” on P. 18. Also note that the speed/acceleration must be reduced as deemed appropriate when operating the vertical axis at the bottom end.

*3 Payload

The payload may be the rated payload or the maximum payload.

The rated payload is the maximum mass that can be transferred at the maximum speed and maximum acceleration. The maximum payload is the maximum mass the actuator can transfer at a reduced speed/acceleration.

When transferring a mass greater than the rated payload, set the load mass and inertial moment in the program, and an optimal speed/acceleration will be applied automatically.

*4 Standard Cycle Time

The standard cycle time refers to the time required to cycle back and forth at maximum speed under the following conditions. This is a general estimate of the high-speed performance.

(Arm length: 350 to 450), 1 kg load, vertical distance: 25mm; horizontal distance: 300mm

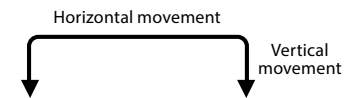

*5 Allowable Inertial Moment at the Tip of the Vertical Axis

The allowable inertial moment at the tip of the vertical axis represents an equivalent allowable inertial moment at the tip of the vertical axis of a SCARA robot (measured at the center of the guide shaft in the case of a 3-axis specification, or center of the rotating axis in the case of a 4-axis specification).

Keep the offset from the center of rotation of the tip of the vertical axis to the center of gravity of the load to 30mm or less in the horizontal direction or 100mm or less in the vertical direction.

If the center of gravity of the tool is away from the center of the tip of the vertical axis, the speed/acceleration must be reduced as deemed appropriate.

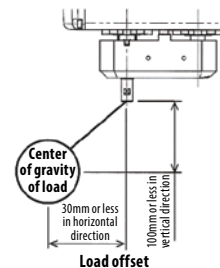

Work Envelope

When changing the arm, be careful that no peripheral objects will obstruct the arm when it fully extends.

Acceleration/Deceleration Setting

For the setting of acceleration/deceleration, refer to “Reference for SCARA Robot Acceleration/Deceleration Settings” on P.18.

*1 to *5 above correspond to the numbers on the main text pages (P. 7, P. 9).

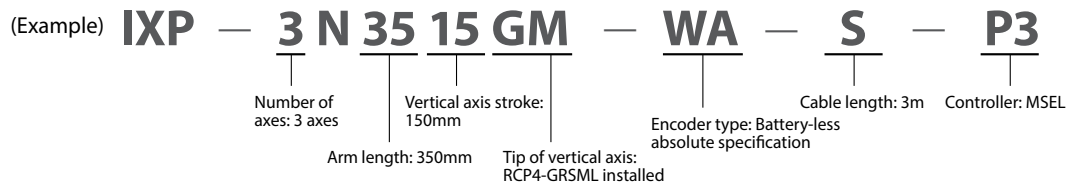
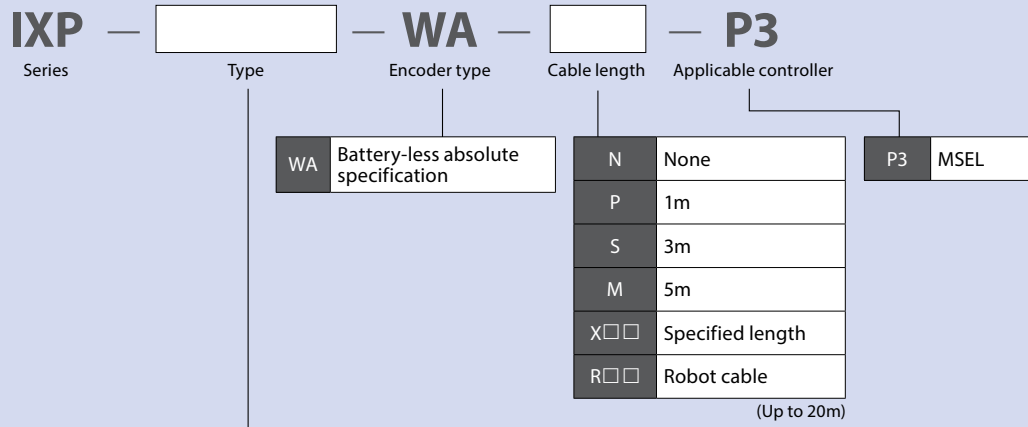

IXP- 3N3515 / 3N3510 / 4N3515

Arm length 350mm
Vertical axis 100mm/150mm

Model Specification Items	IXP	N 35	WA	P3			
Series	Number of axes	Arm length	Vertical axis stroke	Gripper	Encoder type	Cable length	Applicable controller
	3: 3 axes 4: 4 axes	35: 350mm	15 : 150mm, no gripper 15GM: 150mm, medium gripper installed 10GL : 100mm, large gripper installed		WA: Battery-less absolute specification	N: None P: 1m S: 3m M: 5m	X□□: Specified length R□□: Robot cable P3: MSEL

* Refer to "Component Axes" for the gripper types.



* The photograph shows a 4-axis specification.

POINT
Notes on selection

- Refer to P. 5 for *1 through *5.
- The vertical axis has no brake.
- The unique structure holds the load in place even when the servo is turned off.
- The vertical axis does not support push-motion control.
- If a tool is installed or a spring or other buffer is provided for push-motion, the allowable push force is 60 N or less.
- Refer to P. 5 for the work envelope, and P. 18 for the notes on acceleration/ deceleration setting.

Robot Specifications

Axis configuration	Arm length (mm)	Work envelope	Positioning repeatability *1	Maximum operating speed in PTP mode *2			Payload (kg) *3	
				No gripper	With medium gripper (GM)	With large gripper (GL)	Rated	Maximum
Axis 1	Arm 1	160	±0.03mm	2,726mm/s (Composite speed)	2,726mm/s (Composite speed)	1,908mm/s (Composite speed)	1	3
Axis 2	Arm 2	190						
Axis 3	Vertical axis	—						
Axis 4	Rotating axis	—	±360°	±0.02°	1000°/s	—	—	Refer to the catalog of the gripper "RCP4-GR□"
	Medium gripper GM	—	14mm (Both fingers)	±0.01mm	—	94mm/s (One finger)	—	
	Large gripper GL	—	22mm (Both fingers)	±0.01mm	—	125mm/s (One finger)	—	

* When the large gripper is installed, the work envelope of the vertical axis becomes 100mm.

Robot Specifications

	3-axis specification		4-axis specification	
	No gripper	With medium gripper (GM)	With medium gripper (GM)	With large gripper (GL)
Encoder type	Battery-less absolute encoder			
User wiring	AWG24x6, AWG26x5P (shielded) * User cables are sold separately. Refer to the operation manual for detail.		User wiring is not supported because the gripper wiring is used.	
User piping	Air tube (O.D. ø4, I.D. ø2.5) x 3 (Normal working pressure 0.8 MPa)			
Standard cycle time *4 (sec)	SCARA	0.69	0.69	1.08
	Gripper (full stroke)	—	0.51	0.56
Allowable torque (Axis 4) (N · m)	—	1.4	—	
Allowable moment (N · m)	2.9		Ma 1.9 Mb 2.7 Mc 2.9	Ma 2.9 Mb 2.9 Mc 2.9
Allowable inertial moment of tip axis *5 (kg · m ²)	Rated: 0.003 Maximum: 0.01	Rated: 0.003 Maximum: 0.003	0.002	0.009
Ambient temperature/humidity	Temperature: 0~40°C, humidity: 20-85% RH or less (Non-condensing)			
Unit weight (kg)	12	13	12.5	13

Component Axes

IXP-3N3515GM	The medium gripper RCP4-GRSML is installed at the tip of the vertical axis.
IXP-3N3510GL	The large gripper RCP4-GRSLL is installed at the tip of the vertical axis.

Price List

Gripper	SCARA 3-axis specification	Standard price
None	IXP-3N3515	—
Medium gripper	IXP-3N3515GM	—
Large gripper	IXP-3N3510GL	—

Gripper	SCARA 4-axis specification (with rotating axis)	Standard price
None	IXP-4N3515	—

Cable Length <Per Axis*>

Type	Cable code	Standard price
Standard type	P(1m)	—
	S(3m)	—
	M(5m)	—
Special length	X06(6m)~X10(10m)	—
	X11(11m)~X15(15m)	—
	X16(16m)~X20(20m)	—
Robot cable	R01(1m)~R03(3m)	—
	R04(4m)~R05(5m)	—
	R06(6m)~R10(10m)	—
	R11(11m)~R15(15m)	—
	R16(16m)~R20(20m)	—

* The 3-axis specification requires three cables, while the gripper specification and 4-axis specification require four cables.

Dimensions



CAD drawings can be downloaded from the website.

www.intelligentactuator.com

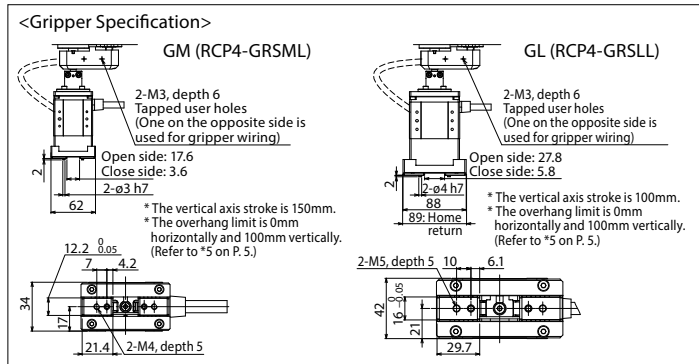
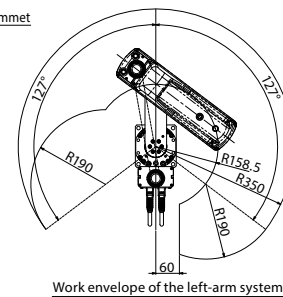
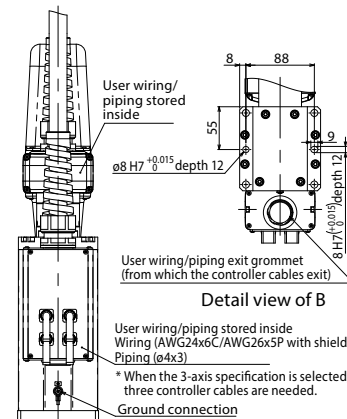
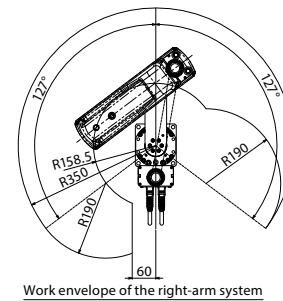
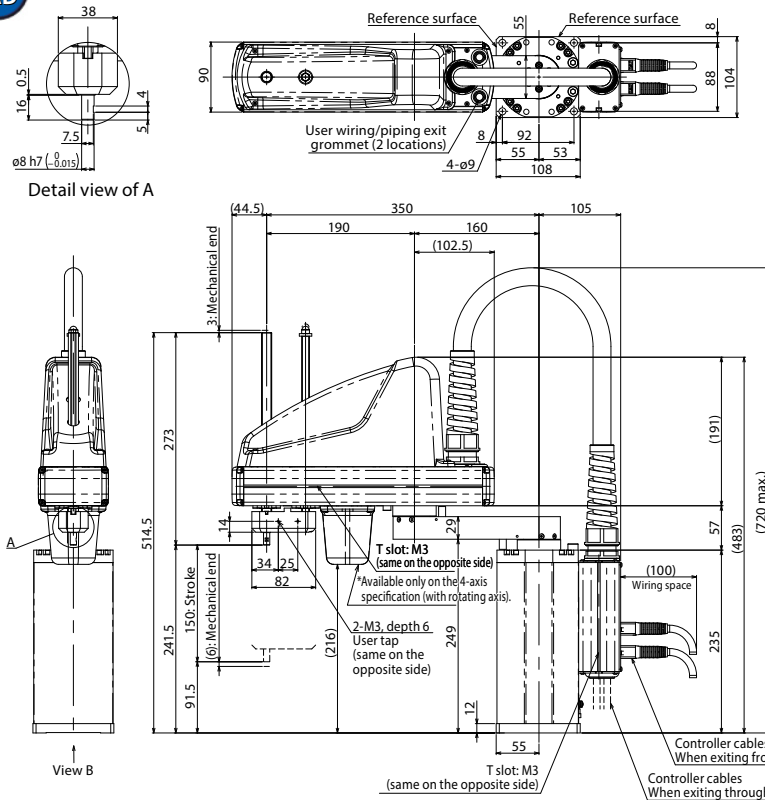

<Flange Dimensions>

An optional flange is available. Use a flange when installing a tool, etc., at the tip of the vertical axis.

Model type	Standard price
IXP-FL-2	—

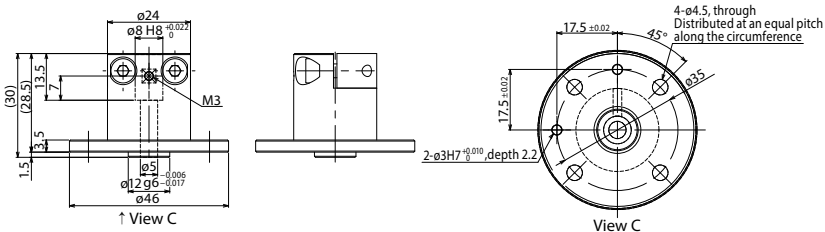

Applicable Controller Specifications

Name	External view	Applicable controller	Features	Standard I/O points (input/output)	Power-supply voltage	Reference page
PowerCON SCARA controller		MSEL	Up to 4 axes	16 points/ 16 points	AC100V~230V	P11

IXP- 3N4515 / 3N4510 / 4N4515

Arm length 450mm
Vertical axis 100mm/150mm

Model Specification Items	IXP	N 45	WA	P3			
Series	Number of axes	Arm length	Vertical axis stroke	Gripper	Encoder type	Cable length	Applicable controller
	3: 3 axes 4: 4 axes	45: 450mm	15 : 150mm, no gripper 15GM: 150mm, medium gripper installed 10GL : 100mm, large gripper installed * Refer to "Component Axes" for the gripper types.		WA: Battery-less absolute specification	N: None P: 1m S: 3m M: 5m	X□□: Specified length R□□: Robot cable P3: MSEL



*The photograph shows a 4-axis specification.

POINT
Notes on selection

- Refer to P. 5 for *1 through *5.
- The vertical axis has no brake.
- The unique structure holds the load in place even when the servo is turned off.
- The vertical axis does not support push-motion control.
- If a tool is installed or a spring or other buffer is provided for push-motion, the allowable push force is 60 N or less.
- Refer to P. 5 for the work envelope, and P. 18 for the notes on acceleration/ deceleration setting.

Robot Specifications

Axis configuration	Arm length (mm)	Work envelope	Positioning repeatability *1	Maximum operating speed in PTP mode *2			Payload (kg) *3		
				No gripper	With medium gripper (GM)	With large gripper (GL)	Rated	Maximum	
Axis 1	Arm 1	260	±0.03mm	2,438mm/s (Composite speed)	2,438mm/s (Composite speed)	2,060mm/s (Composite speed)	1	3	
Axis 2	Arm 2	190							±127°
Axis 3	Vertical axis	—							150mm *
Axis 4	Rotating axis	—	±360°	±0.02°	1,000°/s	—	—	Refer to the catalog of the gripper "RCP4-GR□"	
	Medium gripper GM	—	14mm (Both fingers)	±0.01mm	—	94mm/s (One finger)	—		
	Large gripper GL	—	22mm (Both fingers)	±0.01mm	—	125mm/s (One finger)	—		

*When the large gripper is installed, the work envelope of the vertical axis becomes 100mm.

Robot Specifications

	3-axis specification		3-axis specification	
	No gripper	4-axis specification	With medium gripper (GM)	With large gripper (GL)
Encoder type	Battery-less absolute encoder			
User wiring	AWG24x6, AWG26x5P (shielded) * User cables are sold separately. Refer to the operation manual for detail.		User wiring is not supported because the gripper wiring is used.	
User piping	Air tube (O.D. ø4, I.D. ø2.5) x 3 (Normal working pressure 0.8 MPa)			
Standard cycle time *4 (sec)	SCARA	0.67	0.67	0.95
	Gripper (full stroke)	—	0.51	0.56
Allowable torque (Axis 4) (N · m)	—	1.4	—	
Allowable moment (N · m)	2.9		Ma 1.9 Mb 2.7 Mc 2.9	Ma 2.9 Mb 2.9 Mc 2.9
Allowable inertial moment of tip axis *5 (kg · m ²)	Rated: 0.003 Maximum: 0.01	Rated: 0.003 Maximum: 0.003	0.002	0.009
Ambient temperature/humidity	Temperature: 0~40°C, humidity: 20-85% RH or less (Non-condensing)			
Unit weight (kg)	13	14	132.5	14

Component Axes

IXP-3N4515GM	The medium gripper RCP4-GRSML is installed at the tip of the vertical axis.
IXP-3N4510GL	The large gripper RCP4-GRSLL is installed at the tip of the vertical axis.

Price List

Gripper	SCARA 3-axis specification	Standard price
None	IXP-3N4515	—
Medium gripper	IXP-3N4515GM	—
Large gripper	IXP-3N4510GL	—

Gripper	SCARA 4-axis specification (with rotating axis)	Standard price
None	IXP-4N4515	—

Cable Length <Per Axis*>

Type	Cable code	Standard price
Standard type	P(1m)	—
	S(3m)	—
	M(5m)	—
Special length	X06(6m)~X10(10m)	—
	X11(11m)~X15(15m)	—
	X16(16m)~X20(20m)	—
Robot cable	R01(1m)~R03(3m)	—
	R04(4m)~R05(5m)	—
	R06(6m)~R10(10m)	—
	R11(11m)~R15(15m)	—
	R16(16m)~R20(20m)	—

*The 3-axis specification requires three cables, while the gripper specification and 4-axis specification require four cables.

Dimensions



CAD drawings can be downloaded from the website.

www.intelligentactuator.com

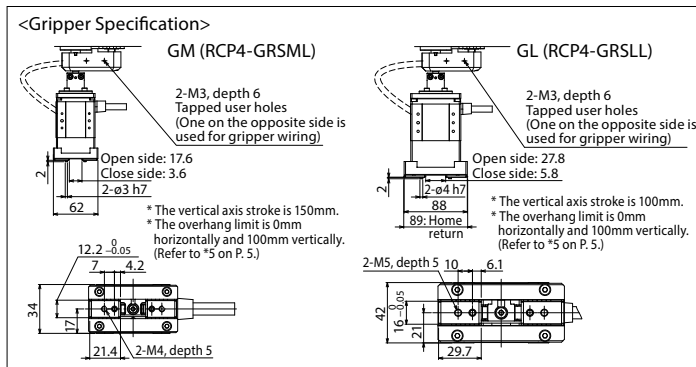
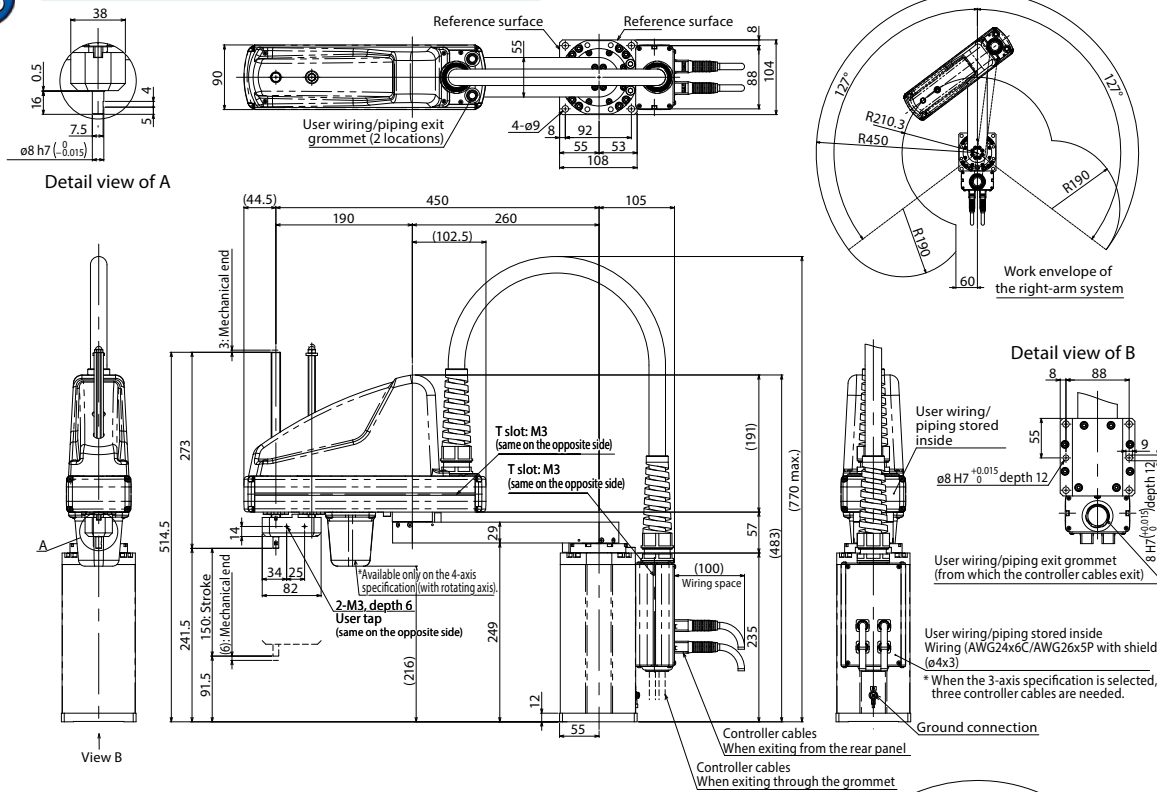

<Flange Dimensions>

An optional flange is available. Use a flange when installing a tool, etc., at the tip of the vertical axis.

Model type	Standard price
IXP-FL-2	—

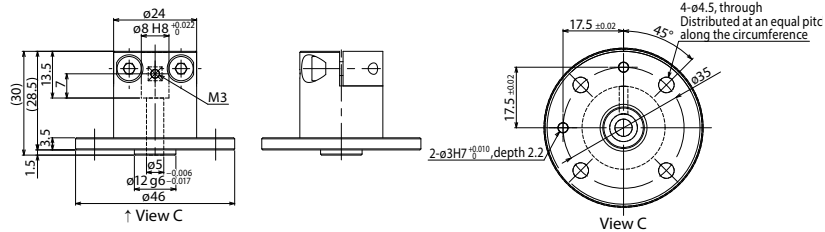

Applicable Controller Specifications

Name	External view	Applicable controller	Features	Standard I/O points (input/output)	Power-supply voltage	Reference page
PowerCON SCARA controller		MSEL	Up to 4 axes	16 points/ 16 points	AC100V~230V	P11

MSEL

MSEL-PCX/PGX
Program Controllers for PowerCON SCARA



Model List

Name	PowerCON SCARA controller			
External view				
Type name	PCX3	PGX3	PCX4	PGX4
Type	3-axis standard specification	3-axis safety category specification	4-axis standard specification	4-axis safety category specification
Standard price	—	—	—	—
Safety category (*1)	B	Can be made compliant with category 3	B	Can be made compliant with category 3
Connected actuator	IXP 3-axis specification		IXP 3-axis specification + additional axis IXP 3-axis gripper specification IXP 4-axis specification (with rotating axis)	
Standard I/Os	NPN, PNP(16IN/16OUT)			
Expansion I/Os	NPN, CC-Link, DeviceNet, PROFIBUS-DP, EtherNet/IP			
Number of programs	255			
Number of program steps	9,999			
Number of positions	30,000			
Power-supply voltage	Single-phase 100 to 230 VAC			

*1: Meeting this safety category requires the customer to install a safety circuit externally to the controller.

Model

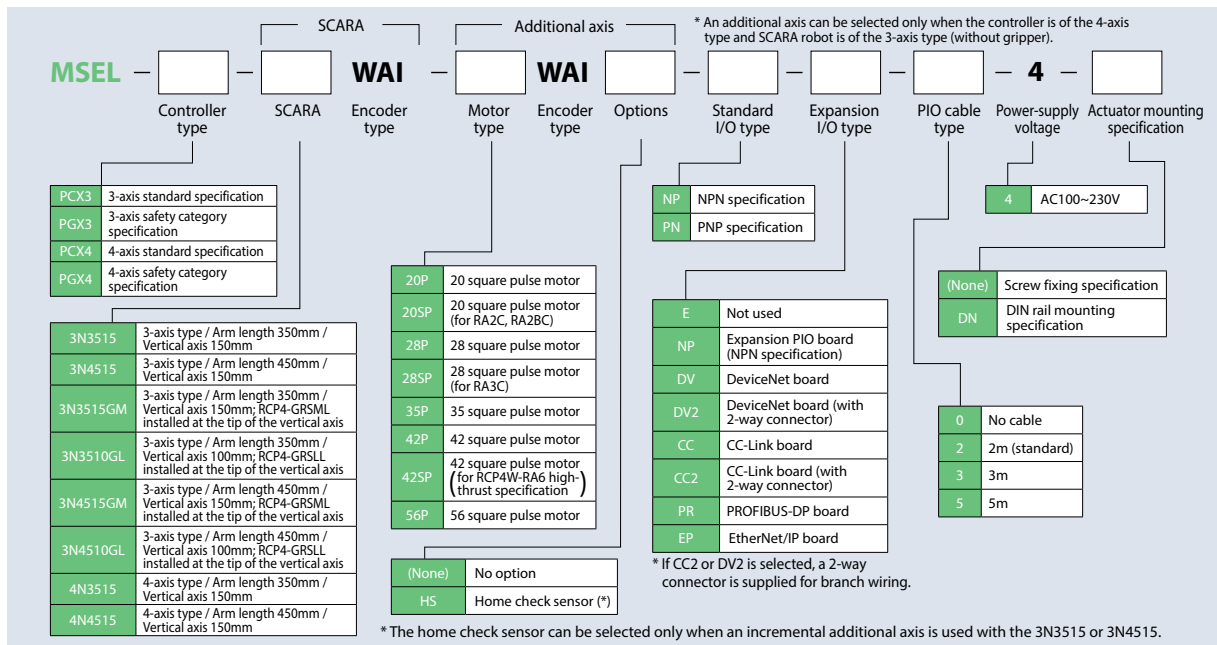

System Configuration

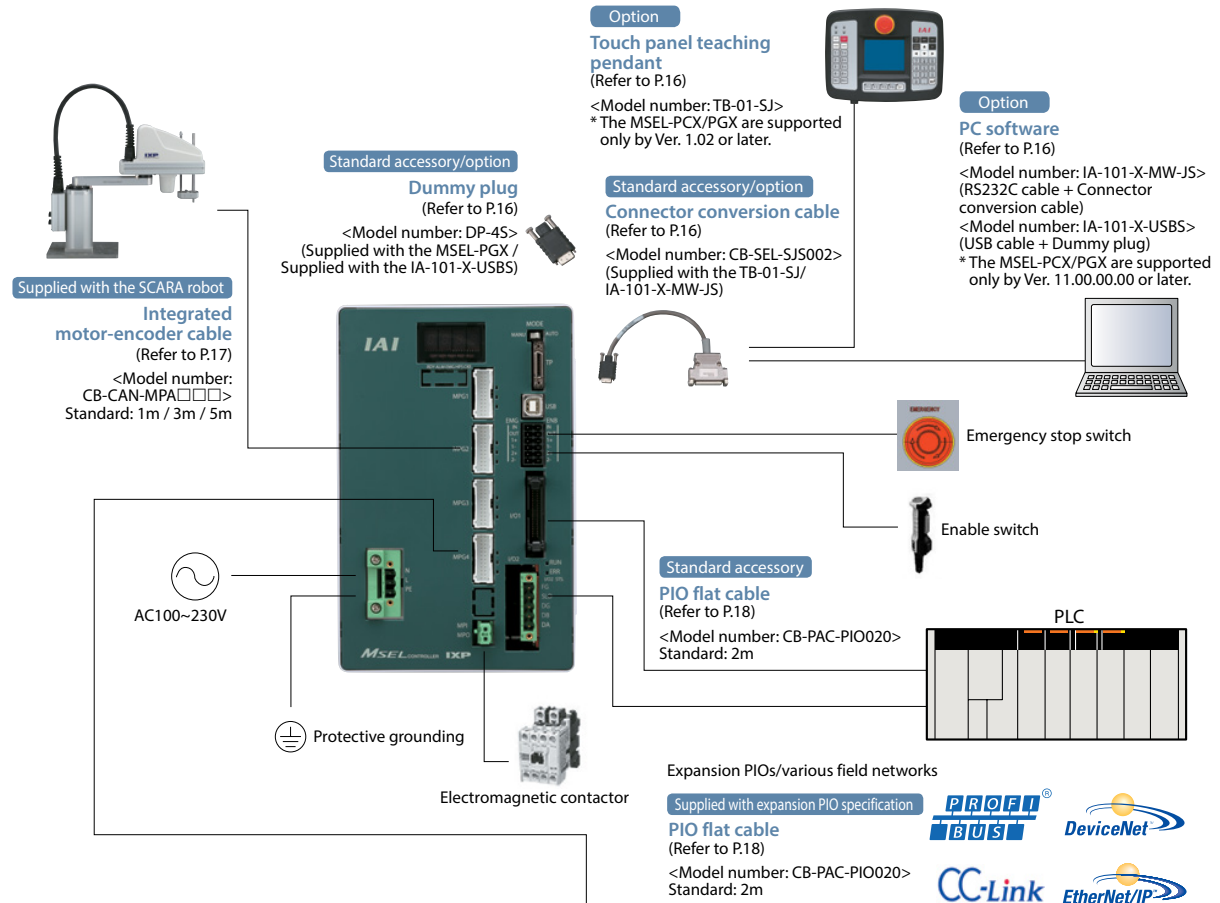

* Wire the emergency stop switch, enable switch, electromagnetic contactor, etc., as necessary. The same applies to the factory settings (shorting).

<Actuator for Additional Axis>

(Can be connected to a SCARA robot of 3-axis specification)

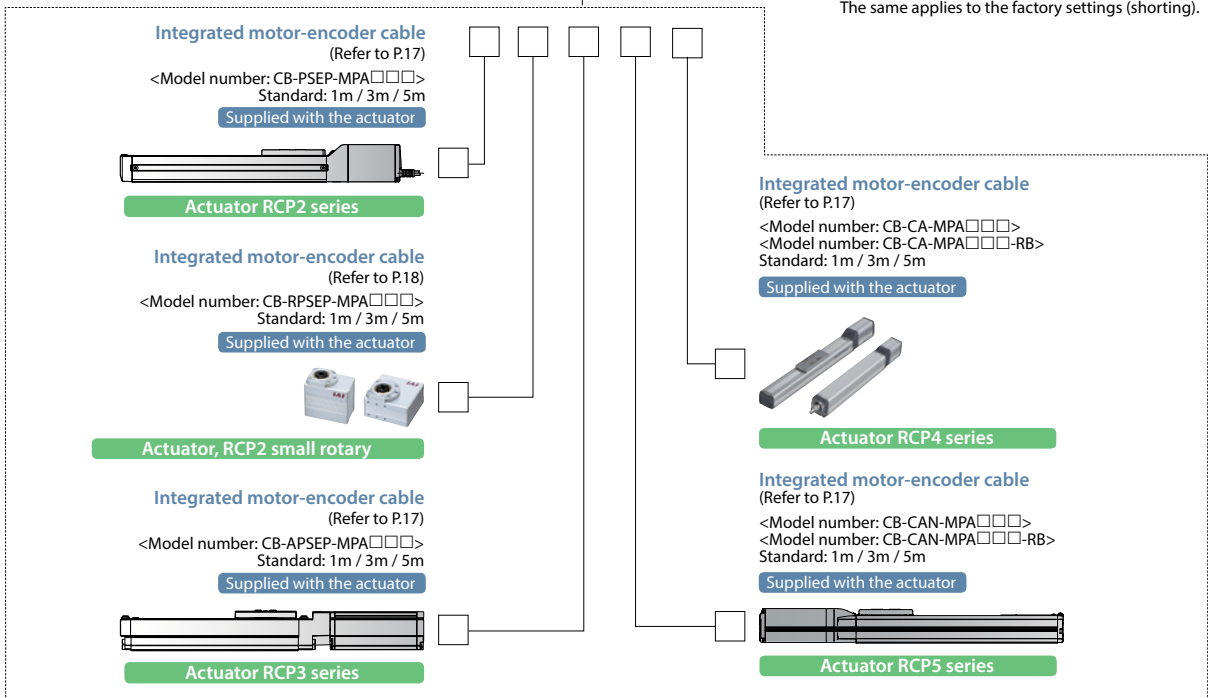

Basic Controller Specifications

Specification item		Contents	
Power-supply input voltage		Single-phase 100 to 230 VAC±10%	
Power-supply current		2.9A typ. (AC100V), 1.4A typ. (AC200V), 1.2A typ. (AC230V)	
Power-supply frequency range		50/60Hz±5%	
Motor type		Pulse motor (servo control)	
Supported encoder		Incremental encoder / Battery-less absolute encoder	
Data storage device		FlashROM/FRAM	
Number of program steps		9,999	
Number of positions		30,000	
Number of programs		255	
Number of multitasks		16	
Operation mode	Serial communications	○	
	Program	○	
SIO interface	Communication method		RS232 (asynchronous communications)
	Baud rate		9.6, 19.2, 38.4, 57.6, 76.8, 115.2kbps
	Live wire connection	TP port	×
		USB	○
Standard PIO interface	Input Specification	Number of input points	16 points
		Input voltage	DC24V±10%
		Input current	7mA/circuit
		ON voltage	Min.DC16V
		OFF voltage	Max.DC5V
		Leak current	Allowable leak current: 1 mA max.
	Insulation method		Photocoupler insulation
	Output specification	Number of output points	16 points
		Load voltage	DC24V±10%
		Maximum current	100mA per point, 400mA per 8 points Note 1
		Saturated voltage	Max.3V
		Leak current	Max.0.1mA
Insulation method		Photocoupler insulation	
Compliant expansion I/O interface		Expansion PIO NPN specification (16IN/16OUT)	
		CC-Link (remote device station)	
		DeviceNet	
		PROFIBUS-DP	
		EtherNet/IP	
Calendar/clock function	Retention time	Approx. 10 days	
	Charge time	Approx. 100 hours (fully charged) * Data can be retained even when the batteries are not fully charged.	
Protective functions		Overcurrent, abnormal temperature, fan speed low monitoring, encoder disconnection, etc.	
Operating temperature range		0~40°C	
Operating humidity range		85% RH max. (non-condensing, non-freezing)	
Installation	Installation direction	Installed vertically (exhaust side up)	
	Installation method	Mounted with screws or using a DIN rail	
Rush current		15A typ. (100 V AC), 30A typ. (200 V AC): 5ms max. (Ambient temperature 25°C/ No cycling of the power)	
Air cooling method		Forced air cooling	
External dimensions		Width 130mm x Height 195mm x Depth 125mm	
Mass		Approx. 1,400g	

Note 1: The total load current shall be 400mA for every eight points from standard I/O No. 316. (The maximum current per point shall be 100mA.)

PIO Signal Chart

Pin Layouts for Standard PIO Connector/Expansion PIO Connector

Pin No.	Category	Assignment	Pin No.	Category	Assignment
1A	24V	P24	1B	Output	OUT0
2A	24V	P24	2B		OUT1
3A	—	—	3B		OUT2
4A	—	—	4B		OUT3
5A	Input	IN0	5B		OUT4
6A		IN1	6B		OUT5
7A		IN2	7B		OUT6
8A		IN3	8B		OUT7
9A		IN4	9B		OUT8
10A		IN5	10B		OUT9
11A		IN6	11B		OUT10
12A		IN7	12B		OUT11
13A		IN8	13B		OUT12
14A		IN9	14B		OUT13
15A		IN10	15B		OUT14
16A		IN11	16B	OUT15	
17A		IN12	17B	—	
18A		IN13	18B	—	
19A		IN14	19B	0V	N
20A	IN15	20B	0V	N	

Internal Circuits for Standard I/Os (NPN Specifications)

[Input section] External input specifications (NPN specifications)

Item	Specifications
Input voltage	DC24V ±10%
Input current	7mA/circuit
On/Off voltage	On voltage...Min. 16.0 VDC, Off voltage...Max. 5.0 VDC
Insulation method	Photocoupler insulation

* The port numbers in the circuit diagram below represent the factory-set port numbers.
 * When the input is off, the allowable leak current is 1mA max.

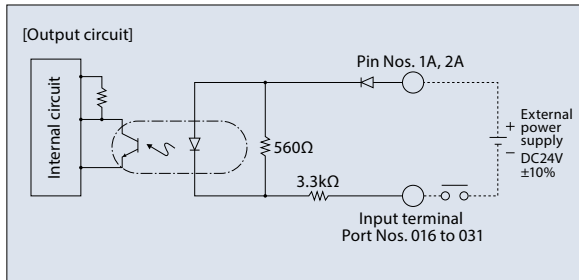

* For the standard IOs (PNP specifications), refer to the operation manual.

[Output section] External output specifications (NPN specifications)

Item	Specifications
Load voltage	DC24V ±10%
Maximum load current	100mA/point, 400mA/8 points Note)
Leak current	Max. 0.1mA/point
Insulation method	Photocoupler insulation

* The port numbers in the circuit diagram below represent the factory-set port numbers.
 Note: The total load current shall be 400 mA for every eight points from standard I/O No. 316. (The maximum current per point shall be 100mA.)

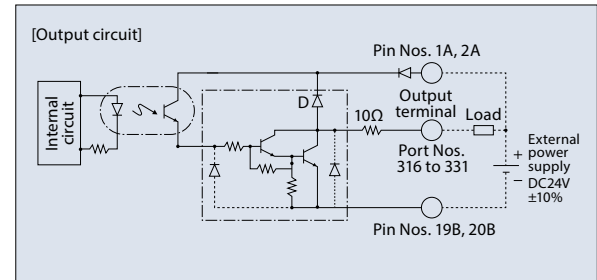

Internal Circuits for Expansion I/Os (NPN Specifications)

[Input section] External input specifications

Item	Specifications
Number of input points	16 points
Input voltage	DC24V ±10%
Input current	4mA/circuit
On/Off voltage	On voltage...Min. 18 VDC (3.5mA) Off voltage...Max. 6.0 VDC (1mA)
Insulation method	Photocoupler insulation

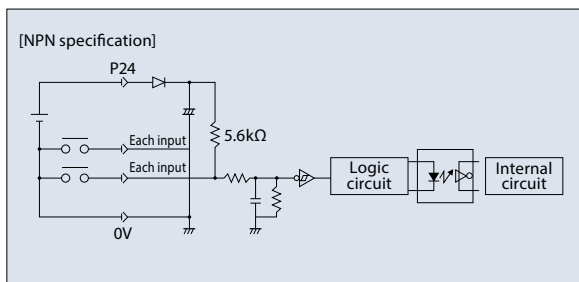

[Output section] External output specifications

Item	Specifications
Number of output points	16 points
Rated load current	DC24V ±10%
Maximum current	50mA/circuit
Insulation method	Photocoupler insulation

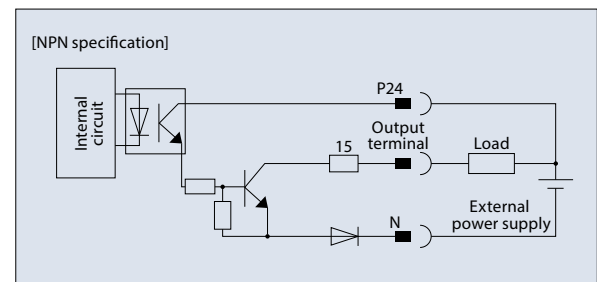

Name of Each Part

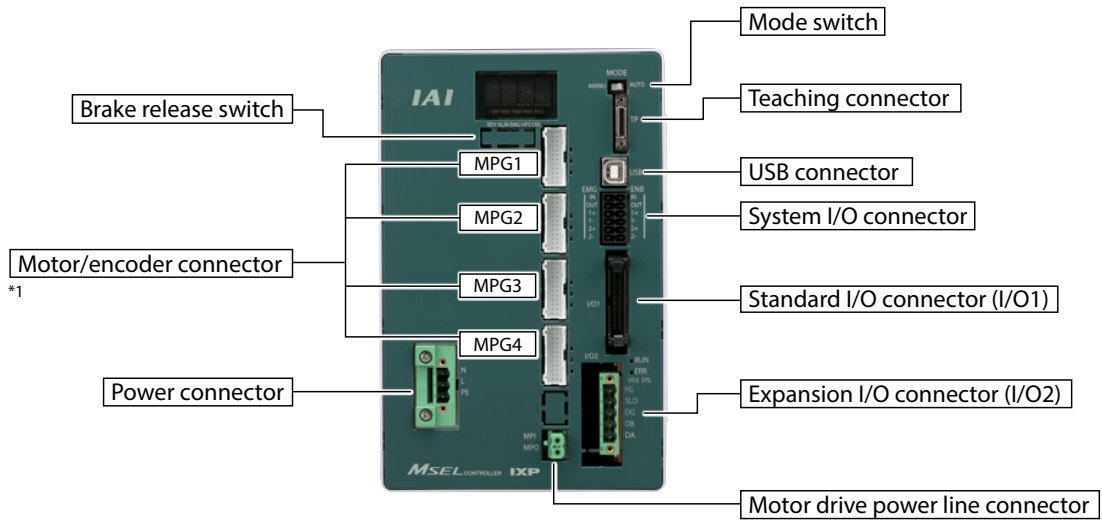

*1: Do not connect a wrong motor to the MPG1, MPG2, MPG3 or MPG4 connector. It may cause malfunction or failure.

External dimensions

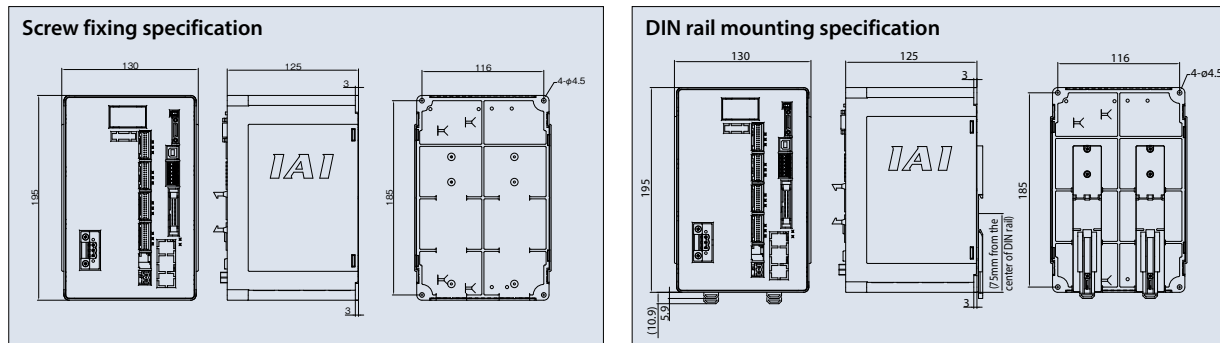

Options

Touch Panel Teaching Pendant

Features A teaching device offering program/position input, trial operation and monitoring functions.

Model number TB-01-SJ

* This model is the standard specification with connector conversion cable. If you are interested in the deadman switch specification, specify the model number of the applicable teaching pendant (TB-01D-N/TB-01DR-N) and that of the cable (CB-TB1-X050-JS).

Configuration

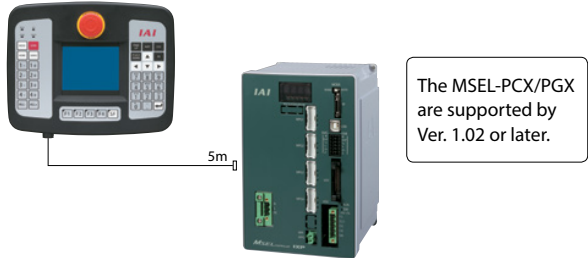

Dummy Plug

Features This plug is required for the safety category specification (MSEL-PGX) and when the MSEL is operated using a USB cable. (The MSEL-PGX type and PC Software IA-101-X-USBS come with this dummy plug.)



Model number DP-4S

Connector conversion cable

Features This cable is used to convert the D-sub 25-pin connector of the teaching pendant or RS232C cable to the MSEL teaching connector. (The TB-01-SJ and IA-101-X-MW-JS come with this connector conversion cable.)

Model number CB-SEL-SJS002

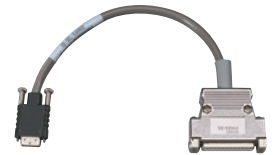

PC Software (Windows Only)

Features The startup support software provides program/position input, test operation and monitoring functions, among others. With its enhanced functions required for debugging, this software helps shorten the startup time.

Model number IA-101-X-MW-JS (RS232C cable + Connector conversion cable)

Configuration

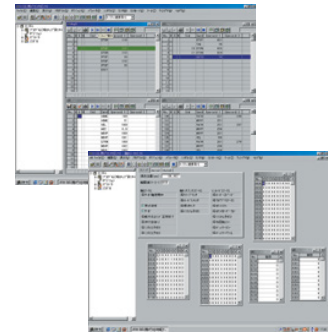
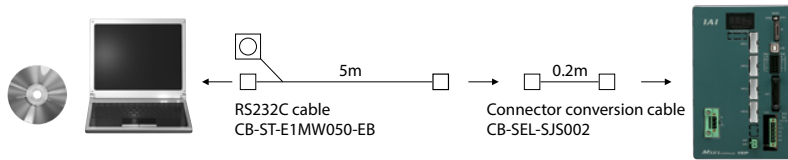

Model number IA-101-X-USBS (USB cable + Dummy plug)

Configuration

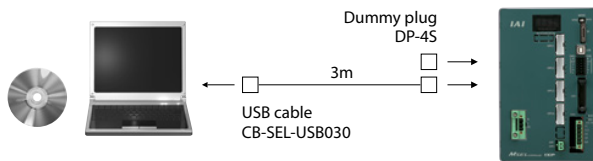

The MSEL-PCX/PGX are supported by Ver. 11.00.00.00 or later.

The CB-ST-E1MW050-EB cannot be used when "Building an enable system that uses a system I/O connector and external power supply" or "Building a redundant safety circuit." (The CB-ST-A1MW050-EB must be used instead.)

Service Parts

Model number	CB-CAN-MPA □□□□	Integrated Motor-Encoder Cable	for IXP/RCP5/RCD
	CB-CAN-MPA □□□□-RB	Integrated Motor-Encoder Robot Cable	

* Please indicate cable length (L) in □□□□, maximum 20m. e.g.) 080 = 8m

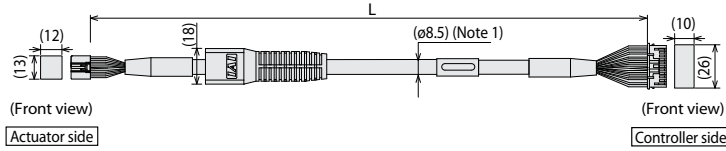

Minimum bending radius 5m or less length R = 68mm or more (for moving parts)
 Longer than 5m R = 73mm or more (for moving parts)

* The robot cable is designed for flex-resistance: Please use the robot cable if the cable has to be installed through a cable track.

(Note 1) If the cable is 5m or longer, ø9.1 cable diameter applies for a non-robot cable and ø10 for a robot cable.

Pin No.	Signal name	Pin No.	Signal name
3	øA/U	1	øA/U
5	VMM/V	2	VMM/V
10	ø A/W	3	ø A/W
9	øB/-	4	øB/-
4	VMM/-	5	VMM/-
15	ø B/+	6	ø B/+
8	LS+/BK+	7	LS+/BK+
14	LS-/BK-	5	LS-/BK-
12	-/A+	11	-/A+
17	-/A-	12	-/A-
1	A+/B+	13	A+/B+
6	A-/B-	14	A-/B-
11	B+/Z+	15	B+/Z+
16	B-/Z-	16	B-/Z-
20	BK+/LS+	9	BK+/LS+
2	BK-/LS-	10	BK-/LS-
21	LS GND	17	LS GND
7	VPS	19	VPS
15	VCC	15	VCC
13	GND	20	GND
19	-	22	-
22	BAT+	21	BAT+
23	-	23	-
24	FG	24	FG

Model number	CB-CA-MPA □□□□	Integrated Motor-Encoder Cable	for Additional Axis RCP4
	CB-CA-MPA □□□□-RB	Integrated Motor-Encoder Robot Cable	

* Please indicate cable length (L) in □□□□, maximum 20m. e.g.) 080 = 8m

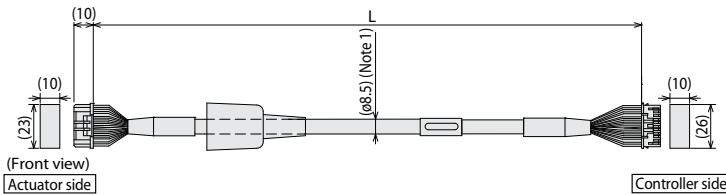

Minimum bending radius 5m or less length R = 68mm or more (for moving parts)
 Longer than 5m R = 73mm or more (for moving parts)

* The robot cable is designed for flex-resistance: Please use the robot cable if the cable has to be installed through a cable track.

(Note 1) If the cable is 5m or longer, ø9.1 cable diameter applies for a non-robot cable and ø10 for a robot cable.

Pin No.	Signal name	Pin No.	Signal name
A1	øA/U	1	øA/U
B1	VMM/V	2	VMM/V
A2	ø A/W	5	ø A/W
B2	øB/-	4	øB/-
A3	VMM/-	6	VMM/-
B3	ø B/+	7	ø B/+
A4	LS+/BK+	8	LS+/BK+
B4	LS-/BK-	11	LS-/BK-
A5	-/A+	12	-/A+
B5	-/A-	13	-/A-
A6	A+/B+	14	A+/B+
B6	A-/B-	15	A-/B-
A7	B+/Z+	16	B+/Z+
B7	B-/Z-	17	B-/Z-
A8	BK+/LS+	9	BK+/LS+
B8	BK-/LS-	10	BK-/LS-
A9	LS GND	20	LS GND
B9	VPS	18	VPS
A10	VCC	17	VCC
B10	GND	19	GND
A11	-	21	-
B11	FG	22	-
		23	-
		24	FG

Model number	CB-APSEP-MPA □□□□-LC	Integrated Motor-Encoder Cable	for Additional Axis RCP3/RCA2, etc.
	CB-APSEP-MPA □□□□	Integrated Motor-Encoder Robot Cable	

* Please indicate cable length (L) in □□□□, maximum 20m. e.g.) 080 = 8m

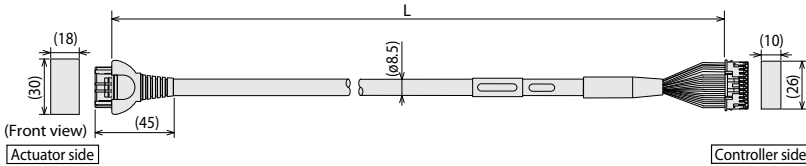

Minimum bending radius R = 68mm or more (for moving parts)

* The robot cable is designed for flex-resistance: Please use the robot cable if the cable has to be installed through a cable track.

Actuator side Pin No.	Signal name	Controller side Pin No.	Signal name
B1	(øA) (U)	1	(øA) (U)
A2	(VMM) (V)	2	(VMM) (V)
B2	(øA) (W)	5	(øA) (W)
A3	(øB) (-)	4	(øB) (-)
B3	(VMM) (-)	6	(VMM) (-)
A4	(øB) (+)	7	(øB) (+)
B4	(LS+) (BK+)	8	(LS+) (BK+)
A5	(LS-) (BK-)	11	(LS-) (BK-)
B5	(-) (A-)	12	(-) (A-)
A6	(+) (A+)	13	(+) (A+)
B6	(+) (B+)	14	(+) (B+)
A7	(-) (B-)	15	(-) (B-)
B7	(+) (Z+)	16	(+) (Z+)
A8	(-) (Z-)	17	(-) (Z-)
B8	(B+) (Z+)	18	(B+) (Z+)
A9	(B-) (Z-)	19	(B-) (Z-)
B9	(BK+) (LS+)	9	(BK+) (LS+)
A10	(BK-) (LS-)	10	(BK-) (LS-)
B10	(GNDLS) (GNDLS)	20	(GNDLS) (GNDLS)
A11	(VPS) (VPS)	18	(VPS) (VPS)
B11	(VCC) (VCC)	17	(VCC) (VCC)
	(GND) (GND)	19	(GND) (GND)
	NC	21	NC
	NC	22	NC
	Shield (FG) (FG)	24	Shield (FG) (FG)
	NC	23	NC

Model number	CB-PSEP-MPA □□□□	Integrated Motor-Encoder Robot Cable	for Additional Axis RCP2
--------------	-------------------------	--------------------------------------	--------------------------

* Please indicate cable length (L) in □□□□, maximum 20m. e.g.) 080 = 8m

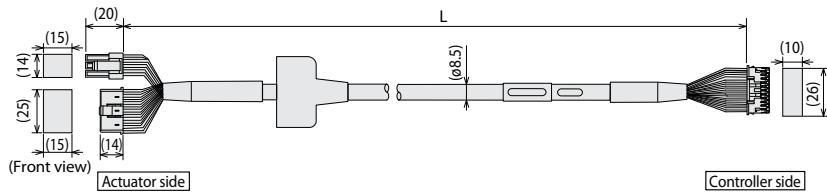

Minimum bending radius R = 68mm or more (for moving parts)

Actuator side Pin No.	Signal name	Controller side Pin No.	Signal name
1	(øA)	1	(øA)
2	(VMM)	2	(VMM)
4	(øB)	3	(øB)
5	(VMM)	4	(VMM)
3	(øA)	5	(øA)
6	(øB)	6	(øB)
9	(BK+)	9	(BK+)
10	(BK-)	10	(BK-)
11	NC	11	NC
12	(LS+)	12	(LS+)
13	(LS-)	13	(LS-)
14	(A+)	14	(A+)
15	(A-)	15	(A-)
16	(B+)	16	(B+)
17	(B-)	17	(B-)
18	(VCC)	17	(VCC)
19	(VPS)	18	(VPS)
20	(Spare)	20	(Spare)
21	(GND)	19	(GND)
22	(Spare)	21	(Spare)
23	NC	22	NC
24	NC	23	NC
25	Shield (FG)	24	Shield (FG)

Model number **CB-RPSEP-MPA** **Integrated Motor-Encoder Robot Cable** **for Additional Axis RCP2-RTBS/RTBSL/RTCS/RTCSL**

* Please indicate cable length (L) in , maximum 20m. e.g.) 080 = 8m

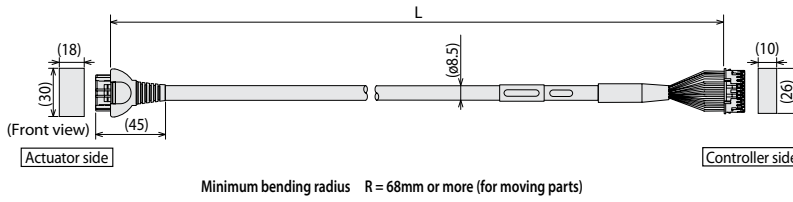

Actuator side			Controller side		
Pin No.	Signal	Wiring	Pin No.	Signal	Wiring
A1	(eA)	1	1	(eA)	1
B1	(VMM)	2	2	(eA)	2
A2	(eA)	3	3	(eB)	3
B2	(eB)	4	4	(VMM)	4
A3	(VMM)	5	5	(eB)	5
B3	(eB)	6	6	(LS+)	6
A4	(LS+)	7	7	(LS-)	7
B4	(LS-)	8	8	(A+)	8
A5	(A+)	9	9	(A-)	9
B5	(A-)	10	10	(B+)	10
A6	(B+)	11	11	(B-)	11
B6	(B-)	12	12	(NC)	12
A7	(NC)	13	13	(BK-)	13
B7	(BK-)	14	14	(BK+)	14
A8	(BK+)	15	15	(GNDLS)	15
B8	(GNDLS)	16	16	(VPS)	16
A9	(VPS)	17	17	(VCC)	17
B9	(VCC)	18	18	(GND)	18
A10	(GND)	19	19	(NC)	19
B10	(NC)	20	20	(NC)	20
A11	(Shield[FG] (FG))	21	21	(NC)	21
B11	(NC)	22	22	(NC)	22
		23	23		

Model number **CB-PAC-PIO** **PIO Flat Cable** **for MSEL/PCON-CA/MSEP-LC**

* Please indicate cable length (L) in , maximum 10m. e.g.) 080 = 8m

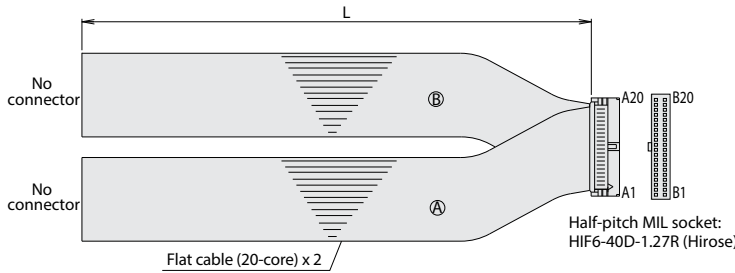

HIF6-40D-1.27R			
No.	Signal name	Cable color	Wiring
A1	24V	Brown-1	B1 OUT0 Brown-3
A2	24V	Red-1	B2 OUT1 Red-3
A3		Orange-1	B3 OUT2 Orange-3
A4		Yellow-1	B4 OUT3 Yellow-3
A5	IN0	Green-1	B5 OUT4 Green-3
A6	IN1	Blue-1	B6 OUT5 Blue-3
A7	IN2	Purple-1	B7 OUT6 Purple-3
A8	IN3	Gray-1	B8 OUT7 Gray-3
A9	IN4	White-1	B9 OUT8 White-3
A10	IN5	Black-1	B10 OUT9 Black-3
A11	IN6	Brown-2	B11 OUT10 Brown-4
A12	IN7	Red-2	B12 OUT11 Red-4
A13	IN8	Orange-2	B13 OUT12 Orange-4
A14	IN9	Yellow-2	B14 OUT13 Yellow-4
A15	IN10	Green-2	B15 OUT14 Green-4
A16	IN11	Blue-2	B16 OUT15 Blue-4
A17	IN12	Purple-2	B17 — Purple-4
A18	IN13	Gray-2	B18 — Gray-4
A19	IN14	White-2	B19 0V White-4
A20	IN15	Black-2	B20 0V Black-4

Reference for SCARA Robot Acceleration/Deceleration Settings

If the robot must be operated continuously, make sure its operations fall within the ranges of the reference graphs for acceleration/deceleration setting and duty cycle setting.

PTP Move

The maximum speed and acceleration/deceleration at which the robot can operate carrying the applicable load are applied as 100% (optimal speed & optimal acceleration/deceleration function). Make adjustments so that the target speed and acceleration/deceleration can be achieved.

- Notes**
- The optimal speed & optimal acceleration/deceleration function does not guarantee robot operation in all operation patterns.
 - If significant vibration generates, reduce the speed and/or acceleration/deceleration because the robot may fail or die prematurely.

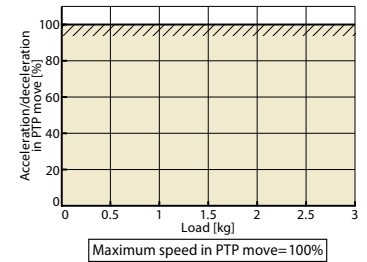

CP Move

Set the speed and acceleration/deceleration at or below the applicable values according to the graph on the right.

- Notes**
- If significant vibration generates, reduce the speed and/or acceleration/deceleration because the robot may fail or die prematurely.

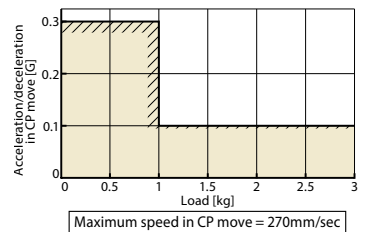

Duty Cycle Setting

The duty cycle refers to a utilization ratio expressed by the percentage of the robot operating time per cycle. For this robot, the duty cycle is limited according to the ambient temperature in order to suppress heat generation from the motor unit and reduction gears. In both PTP move and CP move, the maximum value according to the graph on the right must not be exceeded. Also remember to complete a continuous operation within 30 minutes.

- Notes**
- The duty cycle must not exceed the maximum limit, as it may significantly reduce the life of the motor unit or reduction gears.

